



*sutton*tools

ABRADING & SHARPENING

▪ Carbide Burrs ▪ Die Grinder ▪ Hand Files ▪ Deburring ▪ Diamond Sharpeners

ABRADING & SHARPENING

Abrading & Sharpening Index

- 261 **Abrasives** Mounted Stone Set
- 261 **Air Tools** Die Grinder Kit
- 260 **Carbide Burrs** Double Cut
- 274 **Deburring** Classic Handle
- 274 **Deburring** DisposaBurr
- 270 **Deburring** Glo-Burr E - Heavy Duty
- 274 **Deburring** Handy Chuck
- 273 **Deburring** Long Reach - Countersink
- 273 **Deburring** Long Reach - Heavy Duty
- 275 **Deburring** Professional Kits
- 276 **Deburring** Selection Chart
- 272 **Deburring Sets** Extra Close - Bonus Handle
- 271 **Deburring Sets** Extra Close - Heavy Duty
- 271 **Deburring Sets** Extra Close - Multi-Purpose
- 272 **Deburring Sets** Heavy Duty Sheet Cleaner
- 281 **Diamond Sharpeners** Bench Stone
- 282 **Diamond Sharpeners** Chainsaw
- 280 **Diamond Sharpeners** Double Sided Stone
- 278 **Diamond Sharpeners** EZE Fold
- 282 **Diamond Sharpeners** Fixed Angle
- 278 **Diamond Sharpeners** Hone & Stone
- 285 **Diamond Sharpeners** How To Use
- 284 **Diamond Sharpeners** Needle Files
- 279 **Diamond Sharpeners** Pen Style
- 280 **Diamond Sharpeners** Pocket Stone
- 279 **Diamond Sharpeners** Round, Oval
- 283 **Diamond Sharpeners** Special Use Items
- 263 **Files**
- 268 **Files** Needle Files
- 267 **Files** Sets

Carbide Burrs Double Cut



For shaping or forming metal, to use in air and electric die grinders.
 Double Cut: Allows for rapid stock removal in harder materials.
 The chisel tooth pattern not only minimises tool chatter but reduces the chip to a granular shape in most materials.

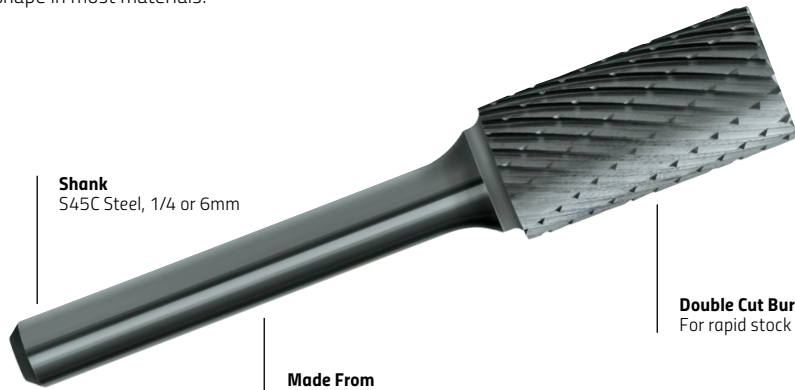

Shank
S45C Steel, 1/4 or 6mm

Double Cut Burrs
For rapid stock removal

Made From Solid Carbide (K30)

Discount Group: B0102

Size	Length	Shank	Item #	Barcode
1/4" Shank				
Cylindrical (Square)				
6.35	16	1/4	918CS0616S^	9311744437122
8	20	1/4	918CS0820S^	9311744437139
12	25	1/4	918CS1225S^	9311744437146
Cylindrical (Radius)				
6.35	16	1/4	918CR0616S^	9311744437153
10	20	1/4	918CR1020S^	9311744437160
12	25	1/4	918CR1225S^	9311744437177
Tree (Radius)				
6.35	16	1/4	918TR0618S^	9311744437184
10	20	1/4	918TR1020S^	9311744437191
12	25	1/4	918TR1225S^	9311744437207
Tree (Pointed)				
6.35	16	1/4	918TP0618S^	9311744437214
10	20	1/4	918TP1020S^	9311744437221
12	25	1/4	918TP1225S^	9311744437238
Flame				
6.35	16	1/4	918FM0618S^	9311744438075
8	20	1/4	918FM0820S^	9311744438082
12	30	1/4	918FM1230S^	9311744438099
5 Pce Set				
12mm x Cylindrical (Square), Cylindrical (Radius), Tree (Radius), Tree (Pointed) & Flame			918CRSET5S^	9311744438112

Size	Length	Shank	Item #	Barcode
6mm Shank				
Cylindrical (Square)				
6.35	16	6	918CS06166^	9311744437566
8	20	6	918CS08206^	9311744437573
12	25	6	918CS12256^	9311744437580
Cylindrical (Radius)				
6.35	16	6	918CR06166^	9311744437597
10	20	6	918CR10206^	9311744437603
12	25	6	918CR12256^	9311744437610
Tree (Radius)				
6.35	16	6	918TR06186^	9311744437627
10	20	6	918TR10206^	9311744437634
12	25	6	918TR12256^	9311744437641
Tree (Pointed)				
6.35	16	6	918TP06186^	9311744437658
10	20	6	918TP10206^	9311744437665
12	25	6	918TP12256^	9311744437672
Flame				
8	20	6	918FM08206^	9311744438051
5 Pce Set				
12mm x Cylindrical (Square), Cylindrical (Radius), Tree (Radius), Tree (Pointed) & Flame			918CRSET5M^	9311744438105

Application

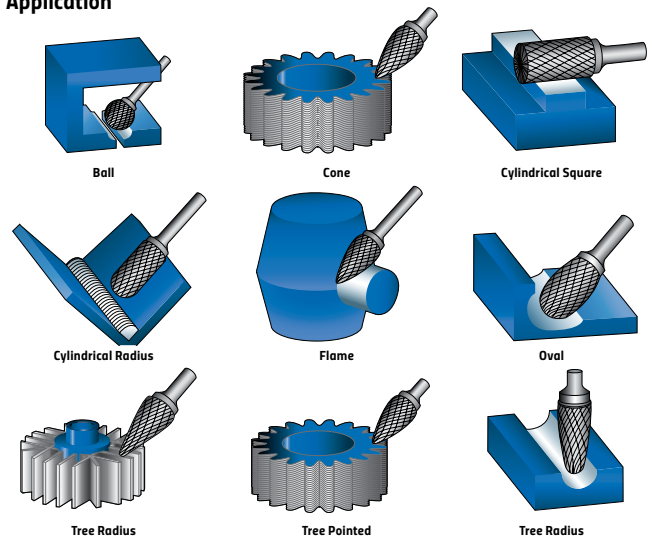

Diameter	Double Cut
Ø 6.35mm	22,000 RPM
Ø 8mm	20,000 RPM
Ø 10mm	18,000 RPM
Ø 12mm	16,000 RPM

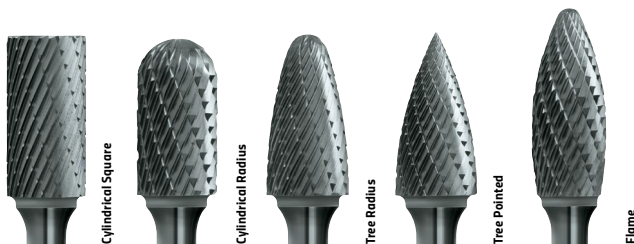

^New look packaging depicted. Actual product packaging may differ from image shown.

Air Tools Die Grinder Kit

suttontools

Sutton Tools Die Grinder is the perfect tool for detailed metal or woodwork providing precise clean cuts. Use it with Sutton Tools range of carbide burs to sculpt and shape harder materials.

Suitable for grinding back and neatening welds, porting, polishing and woodworking applications.



Specifications:

- Collet capacity: 1/8", 1/4", 3mm, 6mm
- No load speed: 25,000 RPM
- Air Pressure: 90 PSI
- Overall Length: 165mm
- Net Weight: 557g



Discount Group: B0102

Description	Contents	Item #	Barcode
Die Grinder Kit	Pneumatic Die Grinder, 4 Collets: 1/8", 1/4", 3mm, 6mm 2 x Wrenches	B902 0002	B902 9311963613628

Recommended Cutting Speeds (RPM) – Standard Length Burs

Diameter	Recommended Cutting Speeds (RPM)			Max RPM
	Steels & Alloys	Stainless Steel	Aluminium	
1/16	33,000	50,000	-	78,000
3/32	26,000	40,000	-	60,000
1/8	23,000	35,000	-	53,000
3/16	17,000	25,000	-	38,000
1/4	15,000	22,000	30,000	33,000
5/16	13,000	20,000	25,000	30,000
3/8	12,000	18,000	20,000	27,000
7/16	11,500	17,000	18,000	26,000
1/2	11,000	16,000	15,000	24,000
5/8	10,000	15,000	12,000	23,000
3/4	9,000	14,000	10,000	21,000
7/8	8,500	13,000	-	20,000
1	8,000	12,000	-	18,000

Note: Reduce cutting speeds by 50% when using long shank carbide burs.

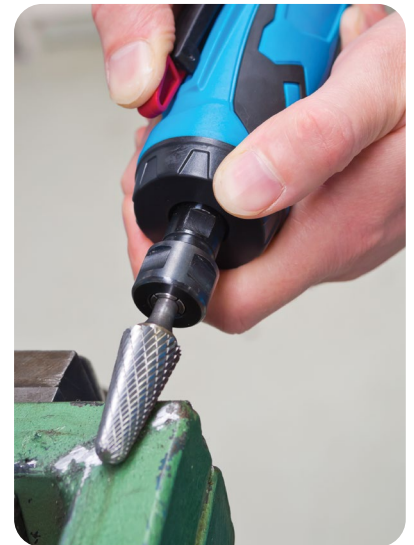

Abrasives Mounted Stone Set

FN[®]

Popular shapes for grinding and sharpening.

Contents:

- 2 x Cylindrical Radius End: 13, 14mm
- 2 x Cylindrical: 10, 25mm
- 1 x Tree 60°: 20mm
- 3 x Tapered: 13, 14, 25mm
- 2 x Ball: 10, 25mm



Discount Group: Z1007

Description	Item #	Barcode
10 Pce Mounted Stone Set	166044671	9311744446711

Choosing The Right File

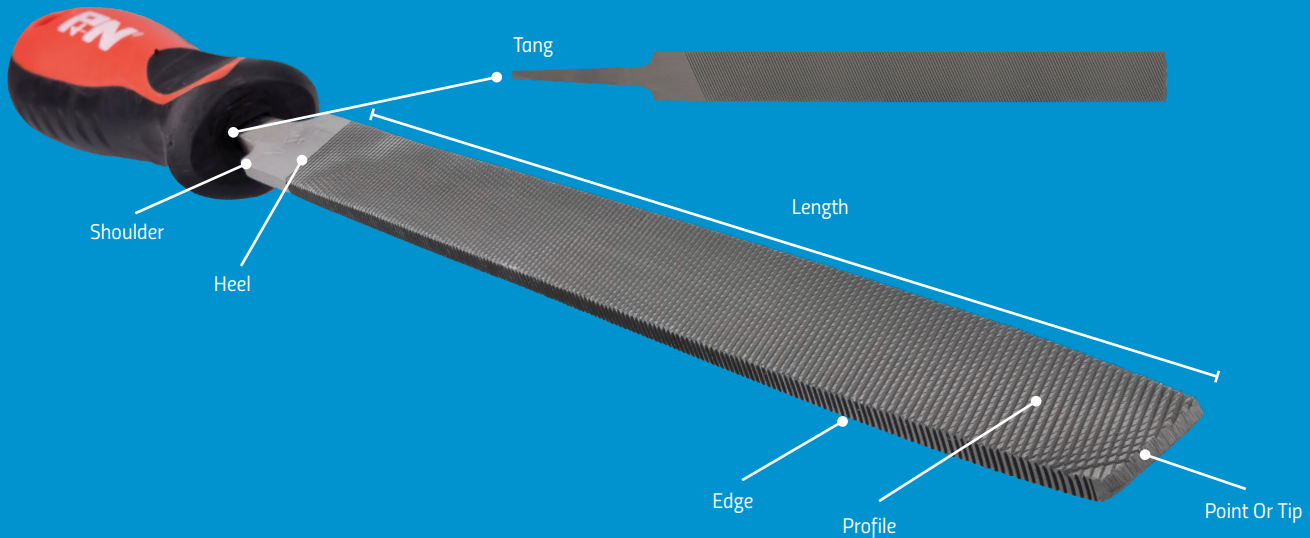

1 Profile

The profile of your file should be the first consideration in tool selection. Choose a profile that best matches your application.

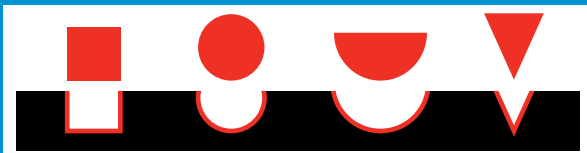

- Flat:** Multi-purpose use on flat and curved external surfaces. Designed for smoothing, removing burrs and sharp edges.
- Square:** For filing slots, keyways, splines and the inside corners of rectangular or square holes.
- Round:** For filing and enlarging holes, circular or rounded grooves.
- Half-round:** For multi-purpose use on concave surfaces, crevices and the rounding out of holes. Can also be used on the flat face.
- Triangular:** Used for sharpening saw teeth and internal corners.

2 Length

Desired stroke length will determine the length of the file. This is measured exclusive of the tang, from point to heel.

3 Cut

These cuts are selected according to the material of the workpiece, the desired removal of material and the surface finish.

- Single Cut:** Single cut files (mostly all saw files are single cut) are used for sharpening and edging applications.
- Double Cut:** Need less effort for filing and also gives a good surface finish.
- Rasp Cut:** Special cut formation for rapid stock removal from surface of softer materials like wood or leather.

4 Coarseness



Smooth Cut:
Fine finish.
For smooth surface finish.



Second Cut:
Medium to coarse finish.
For moderate stock removal.



Bastard Cut:
Coarse finish.
For stock removal.

How to use a file correctly

There are three methods to use a file:

- Straight filing:** Pushing the file lengthwise (straight ahead or slightly diagonally) across the workpiece.
- Draw filing:** Holding the file at each end, pushing and drawing it across the workpiece.
- Lathe filing:** Holding the file against the workpiece in a lathe.

Holding the file

Single Handed Operation:

Hold with the handle resting in your palm with your forefinger at the top of the handle pointing to the tip.

Two Handed Operation:

Hold with the handle resting in your palm with your thumb at the top of the handle pointing to the tip.

Grip the point of the file in the other hand between the thumb and the first two fingers with the thumb being on the top of the file.

Helpful Hints

- Hold the workpiece in a vice at a suitable height to apply adequate pressure.
- To prevent damage to workpiece, use protectors between the workpiece and vice jaws.
- When heavy pressure is required, hold file at tip with thumb pointing forward in line with the file. For lighter pressure, place thumb at right angles to file.
- File on forward stroke only, lifting on back stroke to prevent damaging the file.

Care of the file

- A new file should be used with light pressure in the beginning, preferably on a surface which has been filed earlier.
- Keep file stored away from any water or grease.
- Retain the file packaging, or wrap the file in a cloth for protection.
- Use a wire brush to clean the file teeth.
- Do not use oil on the file.

Files

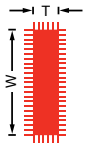

Engineers Flat

For flat and curved external surfaces. Designed for smoothing, removing burrs and sharp edges.



Discount Group: Z0402

Length	W	T	Bulk Qty	Bulk / Unhandled			Single Pack / Handled		
				Item #	Item #	Item #	Item #	Item #	Item #
Engineers Flat									
				Bastard	2nd Cut	Smooth	Bastard	2nd Cut	Smooth
100	12	3	12		300AC0042				
150	16	4	12	300AC0061	300AC0062	300AC0063	300AC1061	300AC1062	
200	20.5	4.45	12	300AC0081	300AC0082	300AC0083	300AC1081	300AC1082	300AC1083
250	25	5.80	12	300AC0101	300AC0102	300AC0103	300AC1101	300AC1102	300AC1103
300	29.8	6.1	6	300AC0121	300AC0122	300AC0123	300AC1121	300AC1122	300AC1123
350	35.5	7.1	6	300AC0141	300AC0142	300AC0143			
				Aluminium	Magic Cut				
250	25	5.8	12		300AM0104				
300	29.8	6.1	6	300AN0120	300AM0124				

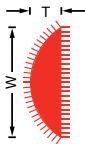

Engineers Half Round

Multi-purpose file for use on concave surfaces and crevices and the rounding out of holes.



Discount Group: Z0402

Length	W	T	Bulk Qty	Bulk / Unhandled			Single Pack / Handled		
				Item #	Item #	Item #	Item #	Item #	Item #
Engineers Half Round									
				Bastard	2nd Cut	Smooth	Bastard	2nd Cut	Smooth
100	12	4	12	300AE0041	300AE0042	300AE0043			
150	16.1	4.7	12	300AE0061	300AE0062	300AE0063			
200	19.8	5.9	12	300AE0081	300AE0082	300AE0083	300AE1081	300AE1082	300AE1083
250	24.6	7.3	12	300AE0101	300AE0102	300AE0103	300AE1101	300AE1102	
300	29.55	8.6	6	300AE0121	300AE0122	300AE0123	300AE1121	300AE1122	
350	34.5	10	6	300AE0141	300AE0142				



Engineers Square

For filing slots, keyways, splines and the inside corners of rectangular or square holes.



Discount Group: Z0402

Length	W	T	Bulk Qty	Bulk / Unhandled			Single Pack / Handled		
				Item #	Item #	Item #	Item #	Item #	Item #
Engineers Square									
				Bastard	2nd Cut	Smooth	Bastard	2nd Cut	Smooth
150	6	6	12	300AJ0061	300AJ0062	300AJ0063	300AJ1061		
200	7.7	7.7	12	300AJ0081	300AJ0082	300AJ0083	300AJ1081		
250	9.6	9.6	12	300AJ0101	300AJ0102	300AJ0103	300AJ1101		
300	12.2	12.2	6	300AJ0121	300AJ0122				



Engineers Round

For filing and enlarging holes, circular or rounded grooves.



Discount Group: Z0402

Length	W	T	Bulk Qty	Bulk / Unhandled			Single Pack / Handled		
				Item #	Item #	Item #	Item #	Item #	Item #
Engineers Round									
				Bastard	2nd Cut	Smooth	Bastard	2nd Cut	Smooth
100	3.8	3.8	12	300AG0041	300AG0042	300AG0043			
125	5	5	12	300AG0051					
150	6.3	6.3	12	300AG0061	300AG0062	300AG0063	300AG1061		
200	7.15	7.15	12	300AG0081	300AG0082	300AG0083	300AG1081		
250	9.25	9.25	12	300AG0101	300AG0102	300AG0103	300AG1101	300AG1102	300AG1103
300	12	12	6	300AG0121	300AG0122	300AG0123	300AG1121		300AG1123

Files

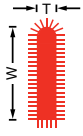

1 Edge Round Mill

For sharpening saws and other tools that require a fine finish. The round edge also allows the filing of saw gullets.



Discount Group: Z0402

Length	W	T	Bulk Qty	Bulk / Unhandled			Single Pack / Handled		
				Item #	Item #	Item #	Item #	Item #	Item #
1 Edge Round Mill				Bastard	2nd Cut	Smooth	Bastard	2nd Cut	Smooth
200	20.4	3.5	12	300CC0081			300CC1081		
250	25.1	4.8	12	300CC0101			300CC1101		
300	30.3	5.3	6	300CC0121			300CC1121		

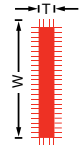

2 Edge Square Mill

For sharpening saws and other tools that require a fine finish.



Discount Group: Z0402

Length	W	T	Bulk Qty	Bulk / Unhandled			Single Pack / Handled		
				Item #	Item #	Item #	Item #	Item #	Item #
2 Edge Square Mill				Bastard	2nd Cut	Smooth	Bastard	2nd Cut	Smooth
150	16	3	12	300CA0061			300CA1061		
200	20.4	3.5	12	300CA0081			300CA1081		
250	25.1	4.8	12	300CA0101	300CA0102		300CA1101		
300	30.3	5.3	6	300CA0121	300CA0122	300CA0123	300CA1121		
350	36	6.5	6	300CA0141					

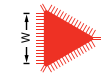

3 Edge Square Mill

For sharpening saws and other tools that require a fine finish.



Discount Group: Z0402

Length	W	T	Bulk Qty	Bulk / Unhandled			Single Pack / Handled		
				Item #	Item #	Item #	Item #	Item #	Item #
3 Edge Square Mill				Bastard	2nd Cut	Smooth	Bastard	2nd Cut	Smooth
150	12		12	300BA0061	300BA0062	300BA0063			
200	15		12	300BA0081	300BA0082	300BA0083			
250	19		12	300BA0101	300BA0102	300BA0103			



Slim Taper

For sharpening saws with a 60° tooth angle.



Discount Group: Z0402

Length	W	T	Bulk Qty	Bulk / Unhandled			Single Pack / Handled		
				Item #	Item #	Item #	Item #	Item #	Item #
Slim Taper				Bastard	2nd Cut	Smooth	Bastard	2nd Cut	Smooth
100	6.1		12	300BE0040			300BE1040		
110	7.2		12	300BE0045					
125	7.2		12	300BE0050					
150	8.8		12	300BE0060			300BE1060		
175	10.5		12	300BE0070					
200	12		12	300BE0080			300BE1080		
Extra Slim Taper									
100	5.0		12	300BG0040					
150	7.2		12	300BG0060					

Files

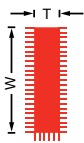

Hand Files

General purpose parallel edge file for flat surfaces, sharp corners and deburring. Features one safe edge to prevent damage when filing into corners.



Discount Group: Z0402

Length	W	T	Bulk Qty	Bulk / Unhandled			Single Pack / Handled		
				Item #	Item #	Item #	Item #	Item #	Item #
Hand Files				Bastard	2nd Cut	Smooth	Bastard	2nd Cut	Smooth
150	16	4	12	300AB0061	300AB0062	300AB0063			
200	20.5	4.45	12	300AB0081	300AB0082	300AB0083			
250	25.0	5.80	12	300AB0101	300AB0102	300AB0103			
300	29.8	6.1	6	300AB0121	300AB0122	300AB0123			

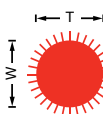

Chainsaw Files

For sharpening chainsaws. Matched to specific chain sizes, the round edge allows the filing of saw gullets.



Discount Group: Z0402

Diameter	Length	Bulk Qty	Bulk / Unhandled		Single Pack / Handled	
			Item #	Item #	Item #	Item #
Chainsaw Files						
1/8	200	12	300DA0460			
5/32	200	12	300DA0580		300DA1580	
3/16	200	12	300DA0680		300DA1680	
7/32	200	12	300DA0780		300DA1780	
1/4	200	12	300DA0880		300DA1880	

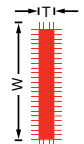

Warding Files

For narrow slots, toolmaking and hobby applications.



Discount Group: Z0402

Length	W	T	Bulk Qty	Bulk / Unhandled			Single Pack / Handled		
				Item #	Item #	Item #	Item #	Item #	Item #
Warding Files				Bastard	2nd Cut	Smooth	Bastard	2nd Cut	Smooth
100	12.1	1.4	12	300AH0041	300AH0042	300AH0043			
150	16.4	2.3	12	300AH0061	300AH0062	300AH0063	300AH1061		
200	20.5	2.9	12	300AH0081	300AH0082	300AH0083			

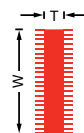

Long Angle Lathe Files

Rapid, free cutting files designed for lathe filing.



Discount Group: Z0402

Length	W	T	Bulk Qty	Bulk / Unhandled			Single Pack / Handled		
				Item #	Item #	Item #	Item #	Item #	Item #
Long Angle Lathe Files				Bastard	2nd Cut	Smooth	Bastard	2nd Cut	Smooth
300	29.8	6.1	6	300AL0121					

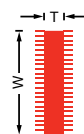

Contact Point

For cleaning electrical contacts such as engine distributor points, spark plugs and switches



Discount Group: Z0402

Length	W	T	Bulk Qty	Bulk / Unhandled			Single Pack / Handled		
				Item #	Item #	Item #	Item #	Item #	Item #
Contact Point				Bastard	2nd Cut	Smooth	Bastard	2nd Cut	Smooth
133	11	1	12	300AP0050					

Files

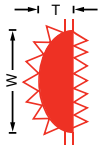

Wood Rasp Half Round
Multi-purpose rasp for use on concave surfaces and crevices, and the rounding out of holes.

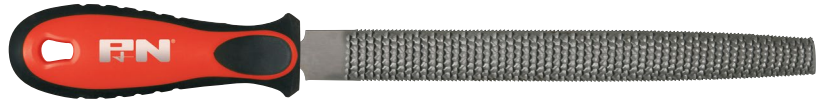

Discount Group: Z0402

Length	W	T	Bulk Qty	Item #	Bulk / Unhandled Item #	Item #	Item #	Single Pack / Handled Item #	Item #	
Wood Rasp Half Round				Bastard	2nd Cut	Smooth		Bastard	2nd Cut	Smooth
200	19.8	5.9	12	300EA0081				300EA1081		
250	24.6	7.3	12	300EA0101				300EA1101		
300	29.55	8.6	6	300EA0121				300EA1121		
350	34.5	10	6	300EA0141						

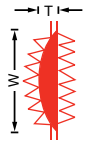

Cabinet Rasp
Punched teeth for rapid removal of soft materials – wood, soft plastics, fibreglass, soft metals. Gives finer finish than wood rasp.

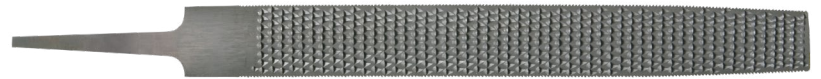

Discount Group: Z0402

Length	W	T	Bulk Qty	Item #	Bulk / Unhandled Item #	Item #	Item #	Single Pack / Handled Item #	Item #	
Cabinet Rasp				Bastard	2nd Cut	Smooth		Bastard	2nd Cut	Smooth
200	23.5	4.5	12	300EC0081	300EC0082			300EC1081		
250	29	6	12	300EC0101	300EC0102			300EC1101		
300	34.5	6.5	6		300EC0122					

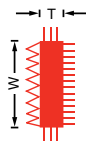

Horse Rasp
Double ended, rasp teeth on one side, file teeth on other. Ideal for shoeing racetrack and riding horses.



300EH0141

300EH0142

Discount Group: Z0402

Length	W	T	Bulk Qty	Item #	Bulk / Unhandled Item #	Item #	Item #	Single Pack / Handled Item #	Item #
Horse Rasp				Tanged	No Tang				
350	42	5.5	6	300EH0141	300EH0142				

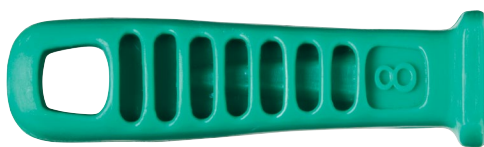

Handles (Bulk)
Economy range. Designed to suit the complete range of P&N® Files.

Discount Group: Z0402

File Length	Qty	Item #	Barcode
Bulk			
100	12	300H00004	9311744156610
150	12	300H00006	9311744156627
200	12	300H00008	9311744156634
250	12	300H00010	9311744156641
300	12	300H00012	9311744156658



Handles (Single Pack)
Soft grip. Designed to suit the complete range of P&N® Files.

Discount Group: Z0402

File Length	Qty	Item #	Barcode
Hang Pack			
100	1	300SGK003	9311744436859
150	1	300SGK004	9311744436866
200-250	1	300SGK005	9311744436873
300	1	300SGK006	9311744436880



Metal File Brush
Ideal brush to remove particles or pins of metal that has become clogged between the teeth of metal files. It is also suitable for surface preparation like removing filings, dirt, rust, burrs, corrosion and other buildup on metal. Ideal for handyman, home improvement and DIY projects.

Discount Group: Z0102

File Length	Qty	Item #	Barcode
190mm	1	300FB1955*	9311744445653

*Not available once current stock is depleted



Sets

Compact storage ideal for your tool box or workshop.



300SE0065^

300SE0083^

300SET004^

300SE0085^

300SE0105^

Discount Group: Z0402

Contents	Case	Pieces	Item #	Barcode
Hand File Sets^				
150mm Bastard: Flat, Round, Millsaw 2nd Cut: Half Round, Square	Nylon Zip	5	300SE0065	9311744445554
200mm Bastard: Flat, Round 2nd Cut: Half Round	Nylon Zip	3	300SE0083	9311744445141
200mm Bastard: Flat, Half Round, Round, Square	Nylon Zip	4	300SET004	9311744438129
200mm Bastard: Flat, Round, Millsaw 2nd Cut: Half Round, Square	Nylon Zip	5	300SE0085	9311744445158
250mm Bastard: Flat, Round, Millsaw 2nd Cut: Half Round, Square	Nylon Zip	5	300SE0105	9311744445165



386911607

Discount Group: Z0402

Contents	Case	Pieces	Item #	Barcode
Needle File Set				
160mm File Handle, Warding-flat, Three Square, Flat, Square, Round, Half Round	Plastic	7	386911607	9311744438136

^New look packaging depicted. Actual product packaging may differ from image shown.

Files Needle Files



These Needle Files are a premium quality and Swiss made. Available in a range of profiles including pillar, half round, crossing, knife edge, warding, square, oval, round, barrette, crochet and pillar.



Discount Group: Z0404

Shape	Style	Length	Pieces	Order Qty*	Item #	Barcode
Needle Files (with integrated, round handle)						
M305						
	Pillar	160	1	12	M305 M001	9311963708744
	Half Round	160	1	12	M305 M002	9311963708751
	Crossing	160	1	12	M305 M003	9311963708768
	Knife Edge	160	1	12	M305 M005	9311963708775
	Warding	160	1	12	M305 M006	9311963708782
	Triangle	160	1	12	M305 M007	9311963708799
	Square	160	1	12	M305 M008	9311963708805
	Oval	160	1	12	M305 M009	9311963708812
	Round	160	1	12	M305 M010	9311963708829
	Barrett	160	1	12	M305 M011	9311963708836
	Crochet	160	1	12	M305 M015	9311963708850
	Pillar (Round edges)	160	1	12	M305 M016	9311963708867
Needle File Sets (in plastic wallet)						
Contains 1 each: M001, M002, M006, M007, M008, M010			6	1	M305 M020	9311963708959
Contains 1 each: M001, M002, M003, M005, M006, M007 M008, M009, M010, M011, M015, M016			12	1	M305 M060	9311963708966

*Orders in multiples of 12

SHAVIV by VARGUS

VARGUS Ltd, established in 1960, is a world leading developer, manufacturer and supplier of cutting and finishing tools to the metalworking and plastics industries. VARGUS is a member of the NEUMO Ehrenberg Group, a diversified multi-national organisation headquartered in Germany.



The Finishing Touch



Applications Guide



Straight Edge
For Sets: B, E, HC, Burr-Bi

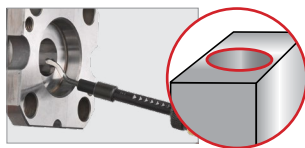

Hole Edge
For Sets: B, E, F, HC

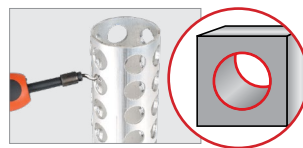

Cross-Hole Both Edge
For Sets: E

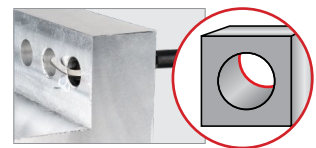

Hole Back-Edge
For Sets: E, HC



Hole Inner Surface
For Sets: HC

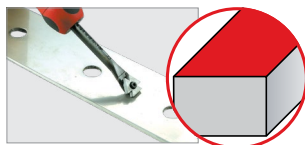

Flat Surface
For Sets: HC



Sheets
For Sets: Burr-Bi

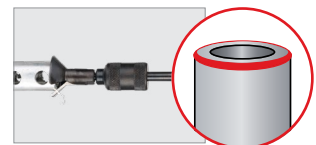

Outer Edge
For Plumber Kit

The Tools of Choice for Industrial Use

SHAVIV deburring blades, sets, kits and tools are the choice of leading companies in the die and mold, automotive, aviation, plastics, electronics assembly, piping and other industries.



Die & Mold



Electrical



Plastic



Automotive



Metal



Plumbing



Aviation

Order your
FREE
WALL CHART
(450 x 720mm)
Item # GP5603



Deburring Glo-Burr E - Heavy Duty

SHAVIV

Leading Deburring Solutions

Glo-Burrs offer a light, yet sturdy solution for hand deburring applications, suitable with all E Series Heavy Duty blades. Designed for deburring of steel, aluminium, copper and plastic, they are great for on-the-go.

Features:

- Lightweight, easy-to-grip handle, made from specially engineered reinforced plastic
- Colour coding for each tool and application
- Interchangeable blades
- Convenient pocket clip
- Removable cap for blade storage



E100 E200 E300 E111



Straight Edge



Hole Edge

Discount Group: Z1003

Set Name	Handle	Blades included	# Item	Barcode
Glo-Burr + E100	Glo-Burr (Green)	E100	SH25529155	9311963636696
Glo-Burr + E200	Glo-Burr (Red)	E200	SH25500268	9311963636702
Glo-Burr + E300	Glo-Burr (Yellow)	E300	SH25500267	9311963636719
Glo-Burr + E111	Glo-Burr (Blue)	E111	SH25500270	9311963636726



Glo-Burr + E100 (Green)
Deburs materials with spiral chips



Glo-Burr + E200 (Red)
Rotates clockwise and counter-clockwise for materials with powdery chips



Glo-Burr + E300 (Yellow)
Deburs inside and outside of holes up to 0.24" (6.0 mm) thick



Glo-Burr + E111 (Blue)
Extra thin. Deburs holes with min. diameter 0.06" (1.5 mm)



Section Index

Deburring Sets Extra Close - Multi-Purpose

SHAVIV
Leading Deburring Solutions

mango II

Works with all B and E blades.
Permanent adapters for simple blade replacement.
Comfortable, ergonomic handle for standard-sized hands.
For deburring materials with spiral or powdery chips.
Deburr Steel, Aluminium, Copper, Brass, Cast Iron and Plastics.



Straight Edge



Hole Edge



Discount Group: Z1003

Set Name	Handle	Blades included	# Item	Barcode
Mango IIB + 1	Mango IIB	B10	SH25590058	9311963624617
Mango IIB + 2	Mango IIB	B10, B20	SH25590060	9311963624624
Mango IIB + 4	Mango IIB	B10, B11, B20, B25	SH25590061	9311963624631

Deburring Sets Extra Close - Heavy Duty

SHAVIV
Leading Deburring Solutions

mango II

Works with all B and E blades.
Permanent adapters for simple blade replacement.
Comfortable, ergonomic handle for standard-sized hands.
For deburring materials with spiral or powdery chips.
Deburr Steel, Aluminium, Copper, Brass, Cast Iron and Plastics.



Straight Edge



Hole Edge



Discount Group: Z1003

Set Name	Handle	Blades included	# Item	Barcode
Mango IIE + 1	Mango IIE	E100	SH25590066	9311963624587
Mango IIE + 3	Mango IIE	E100, E200, E300	SH25590068	9311963624594
Mango IIE + 5	Mango IIE	E100, E111, E120, E200, E300	SH25500162	9311963624600

Deburring Sets Extra Close - Bonus Handle

SHAVIV

Leading Deburring Solutions

mango II

Bonus Packs feature plastic 10-pack packaging for easy storage and removal. Cobalt blades excellent for longer blade life - and great on high end material such as stainless steel.

Each Bonus Pack includes 10 blades and **FREE** Mango II handle. Available with HSS or Cobalt E100 blades.



FREE Handle



Straight Edge



Hole Edge



Flat Surface



Hole Inner Surface



Cross-Hole Both Edges

Discount Group: Z1003

Set Name	Handle	Blades included	# Item	Barcode
HSS 10 X E100	Mango II	10 x E100 (HSS)	SH25500178	9311963624686
Cobalt 10 X E100	Mango II	10 x E100S (Cobalt)	SH25500179	9311963624693

Deburring Sets Heavy Duty Sheet Cleaner

SHAVIV

Leading Deburring Solutions

mango II

For heavy-duty deburring of materials with single or double straight edges up to 0.56" (14mm) thick.

Holder can take two R10 or R20 blades for arc-shaped finishes on workpieces up to 0.63" (16mm) thick. Handguard attached for worker safety.

Deburs Steel, Aluminium, Copper, Brass, Cast Iron and Plastics.



BR



Straight Edge



Sheets

R10



A" side for" spiral chips



B" side for" powdery chips



Discount Group: Z1003

Set Name	Handle	Blades included	# Item	Barcode
Mango II Set Burr-Bi	Mango II	R10 x 2	SH25500206	9311963624853

Deburring Long Reach - Heavy Duty



Rugged deburring set for heavy-duty deburring of holes, slots and edges.
E holder supports all E blades.

The most recommended handle for comfort and control in deburrings.

Simple holder mechanism.

Comfortable, ergonomic handle for standard-sized hands.



Straight Edge



Hole Edge



Cross-Hole
Both Edges



Discount Group: Z1003

Set Name	Handle	Blades included	# Item	Barcode
Mango II Set E	Mango II	E100, E200, E300	SH25590065	9311963624648

Deburring Long Reach - Countersink



Powerful tool, excellent for chamfering and countersinking.

Use for hole-edge applications with up to 0.79" (20mm) diameter.

The most recommended handle for comfort and control in deburrings.

Simple holder mechanism.

Comfortable, ergonomic handle for standard-sized hands.



Hole Edge



Discount Group: Z1003

Set Name	Handle	Blades included	# Item	Barcode
Mango II Set F	Mango II	F20	SH25590071	9311963624747

Deburring Classic Handle

SHAVIV

Leading Deburring Solutions

The classic universal handle. Accepts all Shaviv blade holders. To store spare blades inside handle, simply unscrew the back cap.



Discount Group: Z1003

Description	# Item	Barcode
Classic Handle A	SH25200003	9311963624679

Deburring Handy Chuck

Delivers pin vise versatility for finishing and scraping applications.

Also used for gripping miniature files, drills, reamers, taps, wires, countersinks and other small objects - 0.04"-0.32" (1-8 mm) in diameter.

Handy for assembling electronic components and watch repair.



C50



Straight Edge



Hole Edge



Flat Surface



Hole Inner Surface



Hole Back-Edge

Discount Group: Z1003

Set Name	Handle	Blades included	# Item	Barcode
Shaviv Set HC5	Handy Chuck Pin Vise	C50	SH25500163	9311963624662

Deburring DisposaBurr

Strong, yet lightweight.

Features convenient pocket clip.

Deburrs Steel, Aluminium, Copper and Plastics. Disposable.

Comes with heavy-duty E100 blade.



Straight Edge



Hole Edge



Flat Surface



Hole Inner Surface



Cross-Hole Both Edges



E100

Discount Group: Z1003

Set Name	Handle	Blade included	# Item	Barcode
UB1 DisposaBurr	DisposaBurr	E100	SH25529181	9311963624655

Deburring Professional Kits



Industry tailored, carefully selected deburring tools suitable for specific tasks in a single kit.



Do It Yourself Kit

The essential deburring tools for general home use, DIYers and craftsmen.

The kit contains 9 multi-purpose tools for deburring a wide range of metals, wood and plastic.



Straight Edge Hole Edge Flat Surface



Plumber Kit

Complete burr removal kit for plumbers. Ideal for use on inner and outer edges of tubes.

The kit contains 8 multi-purpose tools for deburring and chamfering metal and plastic.



Straight Edge Hole Edge Outer Edge



Electrician Kit

The most essential deburring tools for electricians.

The kit contains 7 multi-purpose tools for deburring and chamfering metal and plastic.



Straight Edge Hole Edge Flat Surface



Aluminium Works Kit

The easiest and fastest way to hand deburr aluminium material.

The kit contains 6 multi-purpose tools for deburring and chamfering a wide range of aluminium works.

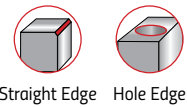

Straight Edge Hole Edge





























Discount Group: Z1003

Set Name	Handle	Holder	Countersink	Blades included	# Item	Barcode
Do It Yourself Kit	Ergonomic Handle for Standard & Heavy Duty Applications	M Holder For B & E Blades for Standard & Heavy Duty Applications	-	HSS E100, HSS E111, HSS E250, HSS E400, Glo Burr B Yellow Handle with HSS B30, HSS B20	SH25400051	9311963624709
Electrician Kit	Ergonomic Handle for Standard & Heavy Duty Applications	F Holder	F12 Inner	MB2000 Handle with HSS E100, HSS E111, HSS E400	SH25400054	9311963624716
Plumber Kit	Ergonomic Handle for Standard & Heavy Duty Applications	F Holder	F26X Outer Diameter	Glo-Burr E Handle with HSS E100, 3 x HSS E100	SH25400055	9311963624723
Aluminium Works Kit	Aluminium Handle	F Holder	F12 Inner	MB2000 Handle with HSS E200, HSS E300	SH25400056	9311963624730

Deburring Selection Chart

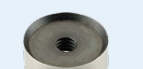

Discount Group: Z1003

Blade Name	Description	Blade (Work Direction Shown)	Applications					Materials							Pce	# Item	Barcode		
			Straight Edge	Hole Edge	Cross-Hole Both Edges	Hole Back-Edge	Sheet	Steel	Aluminium	Copper	Brass	Cast Iron	Stainless Steel	Plastics				Wood	
B10	HSS. Deburrs materials with spiral chips. Bulk pack available.			■	■				■	■	■						2	SH25129212	9311963624556
																	5	SH25129512	9311963624563
																	10	SH25129012*	9311963624570
B20	HSS. Rotates clockwise and counter-clockwise.			■	■												2	SH25119219	9311963624280
																	5	SH25119519	9311963624297
																	10	SH25119019*	9311963624303
B30	Simultaneously deburrs the inside and outside of holes up to 0.16" (4 mm) thick.					■			■	■	■						2	SH25129223	9311963624310
																	5	SH25129523	9311963624327
																	10	SH25129023*	9311963624334
B60	HSS. Removes burrs from back edge of holes up to 0.78" (20 mm) thick.						■		■	■	■						2	SH25129227	9311963624341
																	5	SH25129527	9311963624358
																	10	SH25129027*	9311963624365
E100	Heavy-duty HSS. Deburrs materials with spiral chips.			■	■				■	■	■						2	SH25129234	9311963624372
																	5	SH25129534	9311963624389
																	10	SH25129034*	9311963624396
E110	E shaft, B10 cutting edge for materials with spiral chips. Deburrs holes with min. diameter 0.08" (2 mm).			■	■				■	■	■						2	SH25129238	9311963624402
																	5	SH25129538	9311963624419
																	10	SH25129038*	9311963624426
E200	HSS for materials with powdery chips. Rotates clockwise and counter-clockwise.			■	■												2	SH25129240	9311963624433
																	5	SH25129540	9311963624440
																	10	SH25129040*	9311963624457
E300	HSS for materials with spiral chips. Simultaneously deburrs the inside and outside of holes up to 0.24" (6 mm) thick.					■			■	■	■						2	SH25129242	9311963624464
																	5	SH25129542	9311963624471
																	10	SH25129042*	9311963624488
E350	HSS for materials with powdery chips. Rotates clockwise and counter-clockwise.			■													2	SH25129244	9311963624495
																	5	SH25129544	9311963624501
																	10	SH25129044*	9311963624518
E600	HSS. Removes burrs from back-edges of holes up to 0.78" (20 mm) thick.						■		■	■	■						2	SH25129245	9311963624525
																	5	SH25129545	9311963624532
																	10	SH25129045*	9311963624549
F12	Countersink for hole-edges with up to 0.47" (10 mm) diameter.																1	SH25129049	9311963624754
F20	Countersink for hole-edges with up to 0.78" (20 mm) diameter.																1	SH25129050	9311963624761
F30	Countersink for hole-edges with up to 1.18" (30 mm) diameter.																1	SH25129051	9311963624778
R20	Double-edged, round HSS blade for massive deburring tasks on materials with spiral chips.			■					■	■	■						10	SH25129142	9311963624846

*Pricing for 1 blade in a bulk pack of 10



Proudly Distributed by: **suttontools**
world class cutting tools

Camping

Farming

Fishing

Hospitality

Gardening



EZE-LAP Diamond products have been the pioneer and originator of diamond sharpeners since the early 1970's. Our unique diamond process and modern technology allows EZE-LAP to produce the finest quality diamond products for the lowest possible price. The superior process of heat treatment that bonds the highest quality industrial grade diamond particles in a stainless alloy to a precision matched metal substrate has been imitated but has never come close to being duplicated.

The resulting surface integrity from the EZE-LAP process measures about 72 on the Rockwell C hardness scale.

By utilizing our technology, EZE-LAP has created a surface that works on carbide, ceramic, tool steel, hardened materials and newer stainless steels that are utilized by most major knife manufacturers today.

EZE-LAP manufactures a wide variety of diamond products.

This allows the customer to pick and choose the model(s) they believe will best serve their needs. The vast array of

diamond sharpeners in the product line include small pocket size flat stones and compact, portable, round diamond sharpeners that are ideally suited for the fisherman, sportsman, or the outdoors person, to the larger diamond bench stones ideal for the workshop.

There are even household and professional size diamond steels for the chef, gourmet, or meat cutter. EZE-LAP manufactures products using five different diamond grits. This wide selection in diamond sizes allows you to match the right diamond surface to your specific sharpening application.

In addition to the flat and round sharpeners, EZE-LAP offers several special use diamond sharpening tools, which include chain saw sharpeners, needle files, flat hand files, and oval sharpeners. EZE-LAP boasts about its quality. We are proud to offer the flattest, most consistent production diamond tools available on the market today. Even after years of satisfaction, EZE-LAP customers are still amazed at the quality and consistency of the finishes that are achieved by the diamond tools.

Grit Descriptions: EZE-LAP manufactures products using five different diamond grits. This wide selection of diamond grits allows you to match the right diamond surface to your specific sharpening needs.

Grade	Application	Grit	Colour Code
Super Fine - SF	Used to achieve the ultimate finish. This grit is best for providing a finished, polished edge. Ideally suited for woodworking and industrial applications where the finest finish is necessary. Available on all flat products and all oval sharpening steels.	1200	Blue
Fine - F	Our best general purpose grit. We feel that the great majority of your sharpening needs can be performed by our Fine grit. It has the abrasive ability to effectively sharpen a dull knife to a razor edge quickly and easily. The Fine grit is offered on all EZE-LAP products.	600	Red
Medium - M	When you need a surface that will sharpen quickly but can still achieve a high quality finish the medium grit is perfect for you. This grit is great for re establishing an angle on an edge, taking nicks or chips out of an edge, flattening the soles of hand planes, backs of a chisel or on many lawn and garden tools. Also a good choice for flattening water stones.	400	Purple
Coarse - C	For when you need to get the job done quickly and are looking for rapid metal removal. This grit lends itself well for sharpening axes, shovels, garden tools, shop tools and deburring. Can also be used for flattening of water stones. Coarse is available on flat tools only.	250	Black
Extra Coarse - XC	For very fast aggressive metal removal. Great for roughing in or prepping a surface for final finish. Also used for deburring. Extra Coarse is available on flat tools only.	150	Green

Diamond Sharpeners EZE Fold



Carrying case that unfolds into a handle.
Suitable for knives, scissors, axes, lawn and garden tools.



530

551

591

Colour Coded
For easy grit identification

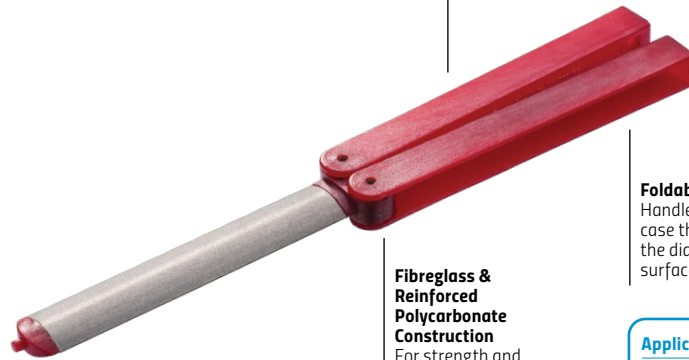

Fibreglass & Reinforced Polycarbonate Construction
For strength and durability

Foldable Handle
Handle folds into a case that protects the diamond surface

Application

DIY
Outdoor
Farming
Fishing
Hospitality
Gardening

Discount Group: Z1401

Size	Description	Grade	Grit	Pieces	Item #	Barcode
Doubled Sided Flat Shaft						
3/4" x 4"	Super Fine/Medium Grit Double Sided, Silver Handle	SF/M	1200/400	1	510	081819510003
3/4" x 4"	Super Fine Grit/Ceramic Double Sided, White Handle	SF	1200	1	530	081819530001
Round Shaft						
3 - 1/2"	Round Shaft, Small & Large Grooves for Hooks, Black Handle	C	250	1	551	081819551006
Tapered Shaft						
3 - 1/2"	Tapered Shaft for Serrated Blades, Fine Grit, Red Handle	F	600	1	571	081819571004
Oval Shaft						
4" x 3/4" x 1/4"	Oval Shaft, Fine Grit, Red Handle	F	600	1	591	081819591002

Diamond Sharpeners Hone & Stone



Suitable for carbides, carbide table saw blades, router bits, deburring, hunting and fishing knives, axes, woodworking tools.



LF

Colour Coded
For easy grit identification

Strong Build
Plastic Polycarbonate handle



Slim Design Pad
3/4" x 2" Diamond for hard to reach places

Application

DIY
Outdoor
Farming
Fishing
Hospitality
Gardening
Woodworking
Metalworking

Discount Group: Z1401

Size	Description	Grade	Grit	Pieces	Item #	Barcode
Hone & Stone						
6" x 3/4"	Super Fine Grit - Blue Handle	SF	1200	1	LSF	081819120004
6" x 3/4"	Fine Grit - Red Handle	F	600	1	LF	081819120011
6" x 3/4"	Medium Grit - Purple Handle	M	400	1	LM	081819120028
6" x 3/4"	Coarse Grit - Black Handle	C	250	1	LC	081819120035
6" x 3/4"	Extra Coarse Grit - Green Handle	XC	150	1	LXC	081819120042
Sets						
6" x 3/4"	3 Pce Set: Super Fine, Fine & Medium Grit in vinyl pouch	SF/F/M	1200/600/400	3	L PAK3	081819121001
6" x 3/4"	5 Pce Set: Super Fine, Fine, Medium, Coarse & Extra Coarse Grit in vinyl pouch	SF/F/M/C/XC	1200/600/400/250/150	5	L PAK5	081819123005

Diamond Sharpeners Pen Style



Stores in a pen type cap.
Clips to pocket, pouch or backpack for easy access in field and workshop.
Suitable for fishing knives, pocket knives, multi-tools, hooks, darts, needles, points, jewellery making.



S



Application

DIY
Outdoor
Farming
Fishing
Jewellery Making

Discount Group: Z1401

Size	Description	Grade	Grit	Pieces	Item #	Barcode
Pen Type						
5 1/2"	D Shaped Shaft with Groove for Fishhooks	F	600	1	S	081819130010
5 1/2"	Pocket Size with Tapered Shaft for Serrated Blades	F	600	1	ST	081819132014

Diamond Sharpeners Round, Oval



Diamond Sharpening Steels provides a new edge every time compared to conventional steels.
Available in round and oval shapes.



G



Application

DIY
Outdoor
Hospitality

Discount Group: Z1401

Size	Description	Grade	Grit	Pieces	Item #	Barcode
Round Sharpener						
8" x 3/8"	Round Shaft Diamond Steel with Plastic Handle	F	600	1	G	081819700015
10" x 7/16"	Round Shaft Diamond Steel with Plastic Handle	F	600	1	P	081819160017
3-1/4" x 1/4"	Diamond Round Shaft Stores in Brass Handle, Pouch with Belt Loop	F	600	1	M	081819190014
Oval Sharpener						
5"	Super Fine Oval with Plastic Handle (Sleeve)	SF	1200	1	D5SF	081819000504
5"	Fine Oval with Plastic Handle Bulk (Sleeve)	F	600	1	D5F	081819000528
5"	Fine Oval with Plastic Handle Bulk (Clam)	F	600	1	D5FC	081819000511
10"	Super Fine Oval with Plastic Handle (Sleeve)	SF	1200	1	D10SF	081819001006
10"	Fine Oval with Plastic Handle (Sleeve)	F	600	1	D10F	081819001013
12"	Super Fine Oval with Plastic Handle (Sleeve)	SF	1200	1	D12SF	081819001204
12"	Fine Oval with Plastic Handle (Sleeve)	F	600	1	D12F	081819001211

Diamond Sharpeners Pocket Stone



Suitable for hunting and fishing knives, woodworking tools, axes, machetes, lawn and garden tools, kitchen and industrial uses.

The stones stay flat and will not dish out or groove. No oil or water is necessary.



26F

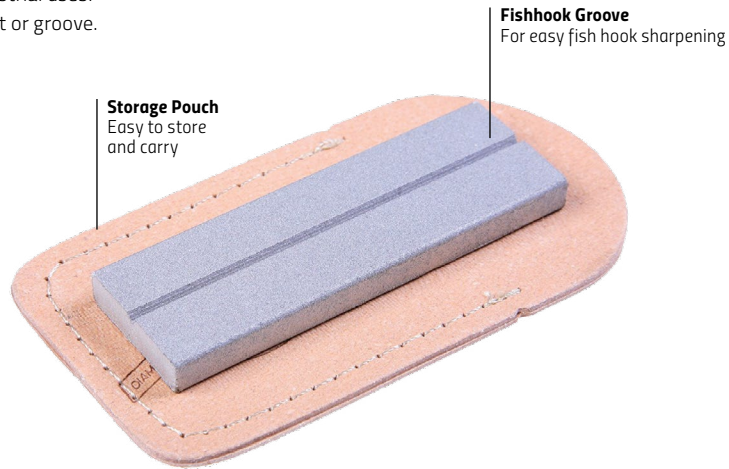

Application

DIY
Outdoor
Farming
Fishing
Hospitality
Gardening
Woodworking
Industrial

Discount Group: Z1401

Size	Description	Grade	Grit	Pieces	Item #	Barcode
Pocket Stone (Includes Pouch)						
1" x 3" x 1/4"	Fine Grit Stone with Groove in Pouch	F	600	1	26F	081819002614
1" x 3" x 1/4"	Super Fine Grit Stone with Groove in Pouch	SF	1200	1	26SF	081819002607
1" x 3" x 1/4"	Medium Grit Stone with Groove in Pouch	M	400	1	26M	081819002621
1" x 4" x 1/4"	Fine Grit Stone with Groove in Pouch	F	600	1	36F	081819003611
Pocket Stone						
1" x 3" x 1/4"	Super Fine Grit Stone with Fishhook Groove	SF	1200	1	21SF	081819002102

Diamond Sharpeners Double Sided Stone



Double-sided stone in grit combinations. Reshape with heavier sided grit, and polish with lighter grit. Non-slip mat for ease of use.



DD6SF/F

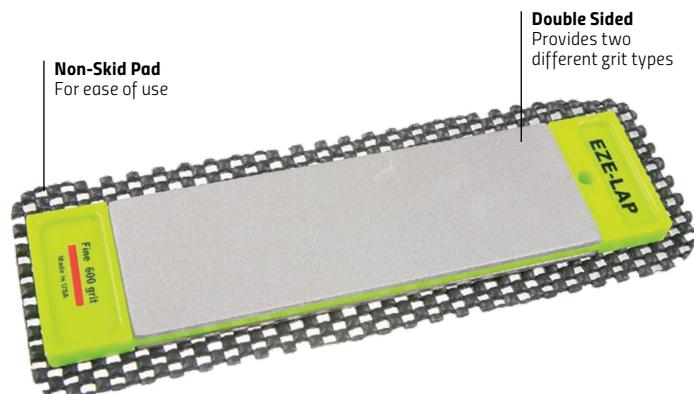

Application

DIY
Hospitality

Discount Group: Z1401

Size	Description	Grade	Grit	Pieces	Item #	Barcode
Double Sided Stone (Includes a Non-Skid Pad)						
2" x 6"	Super Fine/Fine Grit Stone	SF/F	1200/600	1	DD6SF/F	081819446012
2" x 6"	Super Fine/Medium Grit Stone	SF/M	1200/600	1	DD6SF/M	081819446029
2" x 6"	Fine/Coarse Grit Stone	F/C	600/250	1	DD6F/C	081819446135
3" x 8"	Super Fine/Fine Grit Stone	SF/F	1200/600	1	DD8SF/F	081819448016
3" x 8"	Super Fine/Medium Grit Stone	SF/M	1200/400	1	DD8SF/M	081819448023
3" x 8"	Fine/Coarse Grit Stone	F/C	600/250	1	DD8F/C	081819448139

Diamond Sharpeners Bench Stone



Suitable for hunting and fishing knives, woodworking tools, axes, machetes, lawn and garden tools, kitchen and industrial uses. The stones stay flat and will not dish out or groove. No oil or water is necessary.

Walnut Pedestal
For easy handling or bench use

Sharpening Stone
No oil or water is necessary



32F



- Application**
- DIY
 - Outdoor
 - Farming
 - Fishing
 - Hospitality
 - Gardening
 - Woodworking
 - Industrial

Discount Group: Z1401

Size	Description	Grade	Grit	Pieces	Item #	Barcode
Bench Stone (Includes Walnut Pedestal)						
1" x 3"	Fine Grit Stone on a Walnut Pedestal, no groove	F	600	1	22F	081819002218
1" x 4"	Fine Grit Stone on a Walnut Pedestal, no groove	F	600	1	32F	081819003215
1" x 6"	Fine Grit Stone on a Walnut Pedestal	F	600	1	42F	081819004212
2" x 4"	Fine Grit Stone on a Walnut Pedestal	F	600	1	52F	081819005219
2" x 6"	Fine Grit Stone on a Walnut Pedestal	F	600	1	62F	081819006216
2" x 6"	Medium Grit Stone on a Walnut Pedestal	M	400	1	62M	081819006223
2" x 8"	Fine Grit Stone on a Walnut Pedestal	F	600	1	72F	081819007213
Bench Stone						
2" x 4" x 1/4"	Fine Grit Stone	F	600	1	51F	081819005110
2" x 6" x 1/4"	Super Fine Grit Stone	SF	1200	1	61SF	081819006100
2" x 6" x 1/4"	Fine Grit Stone	F	600	1	61F	081819006117
2" x 8" x 1/4"	Super Fine Grit Stone	SF	1200	1	71SF	081819007107
2" x 8" x 1/4"	Fine Grit Stone	F	600	1	71F	081819007114
2" x 8" x 1/4"	Medium Grit Stone	M	400	1	71M	081819007121
3" x 8" x 1/4"	Super Fine Grit Stone	SF	1200	1	81SF	081819008104
3" x 8" x 1/4"	Fine Grit Stone	F	600	1	81F	081819008111
3" x 8" x 1/4"	Medium Grit Stone	M	400	1	81M	081819008128
Flat Plate						
8" x 8"	Coarse Grit Flat Plate	C	250	1	151C	081819015133

Diamond Sharpeners Fixed Angle



Easy clamp on fixed angle kit to ensure proper angle sharpening for perfect results.
Kit includes knife clamp, angle guides, guide rods in a roll pouch.
Comes in superfine, fine and medium diamond sharpening stones.



K011



DMD-KIT

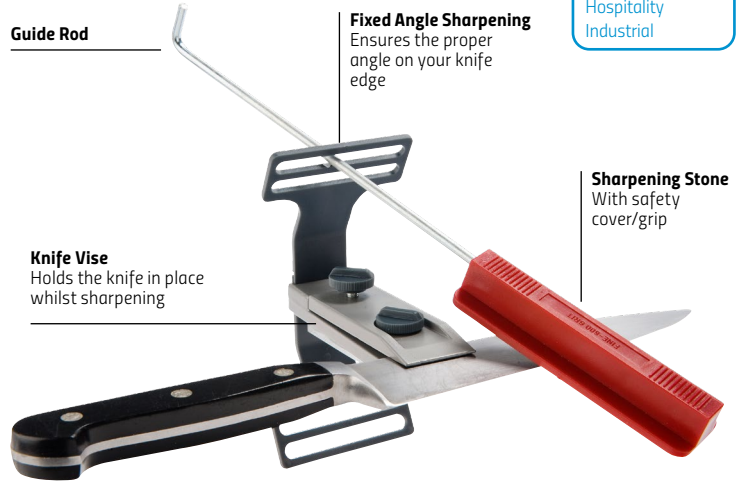

Application

DIY
Hospitality
Industrial

Discount Group: Z1401

Description	Grade	Grit	Pieces	Item #	Barcode
3 Pce Fixed Angle Sharpening Stone Kit					
Includes Super Fine, Fine & Medium	SF/F/M	1200/600/400	3	DMD-KIT	081819413403
Replacement Fixed Angle Sharpening Stone					
Red – Fine	F	600	1	K011	081819110111
Purple – Medium	M	400	1	K012	081819110128
Black – Coarse	C	250	1	K013	081819110135

Diamond Sharpeners Chainsaw



12 volt chainsaw sharpening kit.
Designed for cigarette lighter or battery terminals.
Precision guide for efficient sharpening.

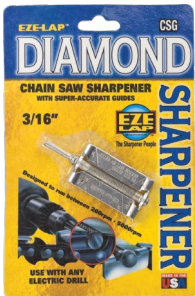

CSG 3/16

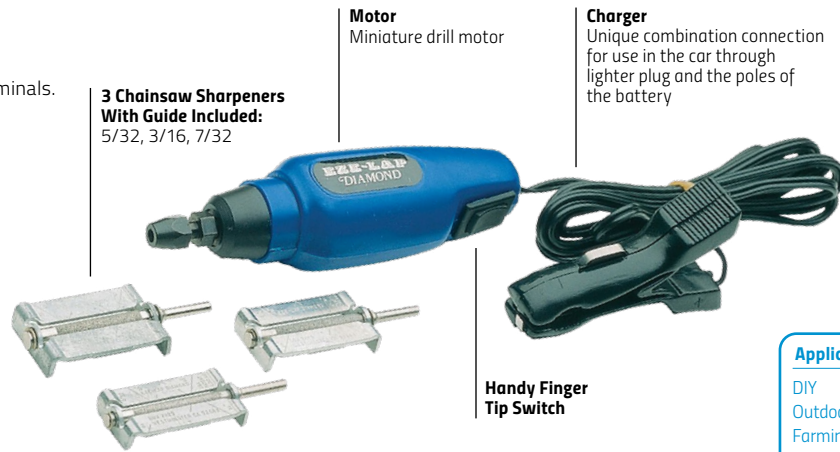

EZELAP Diamond Sharpener Kit CSK

Application

DIY
Outdoor
Farming
Industrial

Discount Group: Z1401

Size	Description	Shank	Pieces	Item #	Barcode
4 Pce Chainsaw Sharpening Kit					
5/32", 3/16", 7/32"	12-Volt Chainsaw Sharpening Kit	1/8	4	CSK	081819110029
Chainsaw Files					
5/32"	Diamond chainsaw file, threaded	1/8	1	CSR 5/32	081819180527
3/16"	Diamond chainsaw file, threaded	1/8	1	CSR 3/16	081819180329
7/32"	Diamond chainsaw file, threaded	1/8	1	CSR 7/32	081819180725
Chainsaw Files with Precision Guide					
5/32"	Diamond chainsaw file with precision guide	1/8	1	CSG 5/32	081819700527
3/16"	Diamond chainsaw file with precision guide	1/8	1	CSG 3/16	081819700329
7/32"	Diamond chainsaw file with precision guide	1/8	1	CSG 7/32	081819700725

Diamond Sharpeners Special Use Items



Credit Card Stone



201

Chisel Care Kit



CCKF

Carbide Knife & Tool Sharpener



EE02

Ceramic Combo Pocket Stone



CD4

Application

- DIY
- Outdoor
- Farming
- Fishing
- Hospitality
- Woodworking

Discount Group: Z1401

Size	Description	Grade	Grit	Pieces	Item #	Barcode
Credit Card Stone						
2" x 3-1/4"	Super Fine Stone	SF	1200	1	200	081819200003
2" x 3-1/4"	Fine Stone	F	600	1	201	081819201000
2" x 3-1/4"	Medium Stone	M	400	1	202	081819202007
Eze Edge						
	Carbide Knife & Tool Sharpener			1	EE02	081819055023
Chisel Care Kit						
50 x 150 x 6mm	Diamond Plate Chisel Guide			1	CCKF	081819661996
Ceramic Combo Pocket Stone						
3/4" x 4"	Double Sided Super Fine Diamond/Ceramic Combo Pocket Stone + Sheath			1	CD4	081819344004

Diamond Sharpeners Needle Files



12 different shapes.

2 durable efficient grits – Fine and Coarse.

Used by Gunsmiths, tool and die makers, jewellers and stockmakers.



600F



600C



605F



605C

Application

DIY
Industrial
Jewellery Making

Discount Group: Z1401

O/A Length	Description	Shape	Grade	Grit	Pieces	Item #	Barcode
Diamond Needle File - Red Handle							
140	Round	○	F	600	1	601F	081819060119
140	Square	□	F	600	1	602F	081819060219
140	Three Square	△	F	600	1	603F	081819060317
140	Half Round	◐	F	600	1	604F	081819060416
140	Flat Warding	▭	F	600	1	605F	081819060516
140	Knife	△	F	600	1	606F	081819060613
140	Hand	▭	F	600	1	608F	081819060812
Diamond Needle File - Purple Handle							
140	Three Square	△	C	250	1	603C	081819060324
140	Half Round	◐	C	250	1	604C	081819060423
140	Flat Warding	▭	C	250	1	605C	081819060522
140	Hand	▭	C	250	1	608C	081819060829
6 Pce Diamond Needle File Sets							
140	Round, Square, Three Square, Half Round, Flat Warding, Knife	○□△◐▭△	F	600	6	600F	081819060010
140	Hand, Crossing, Barrette, Round Edge Joint, Slitting, Pippin	▭○◁▷◇◇	F	600	6	607F	081819060713
140	Round, Square, Three Square, Half Round, Flat Warding, Knife	○□△◐▭△	C	250	6	600C	081819060027
140	Hand, Crossing, Barrette, Round Edge Joint, Slitting, Pippin	▭○◁▷◇◇	C	250	6	607C	081819060720

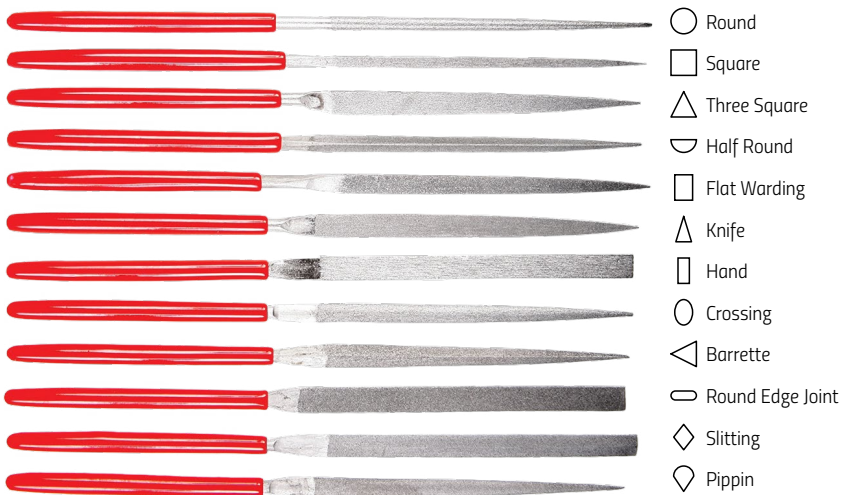

Diamond Sharpeners How To Use

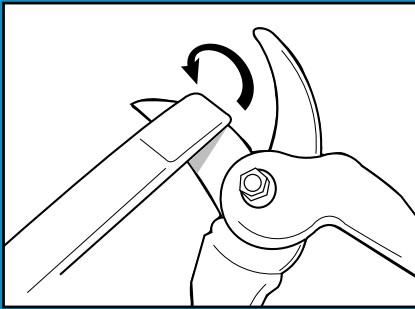

Secateurs - LF

Open your secateurs and locate the ground angled edge. Lay the diamond pad flat on the angle, then raise slightly and rub in small circles along the full length of the blade. Start with a firm pressure then finish lightly. Use and clean regularly.

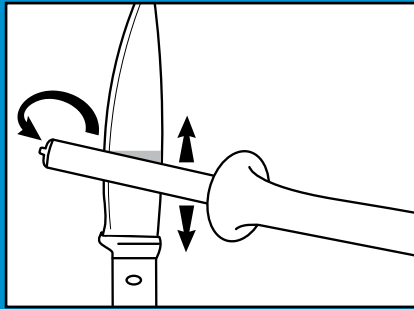

Knives - D5F

Holding your knife steady, lay the diamond shaft flat on the blade, lift slightly (so you are not touching the blade face). Rub in small circles or up and down along the blade length, try keeping the angle the same doing both sides evenly. Start with a firm pressure then finish lightly. Use and clean regularly.

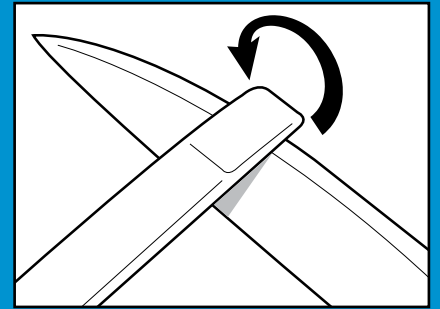

Knives - LF

Hold your knife steady, lay the diamond pad flat on the blade, lift slightly (so you're not touching the blade face). Rub in small circles or up and down along the blade keeping the angle the same. Do both sides evenly. Start with a firm pressure then finish lightly. Use and clean regularly.

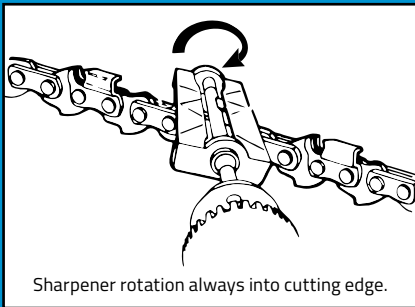

Sharpener rotation always into cutting edge.

Diamond Chainsaw Sharpeners - CSG

Put Sharpener and guide on tooth. Align with cutting edge. Start drill motor, hold steadily in place.

Do not oscillate or reciprocate.
Use with standard drill motor.
Apply thumb side pressure to side of guide.
Do not apply side pressure to drill motor.

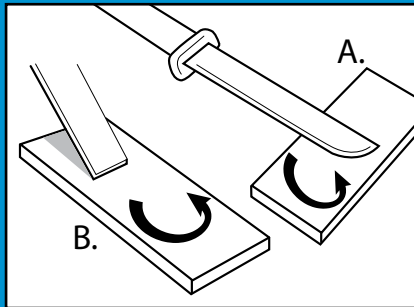

Knives & Tools - 61F or 72F

A. Lay your knife flat on the diamond plate, lift slightly (so you're not touching the blade face). Rub in small circles or up and down along the blade length, keeping the angle the same doing both sides evenly. Start with a firm pressure then finish lightly.

B. Position the ground angle on the plate. Use a circular or up/down action to shape the edge.

Turn blade over flat to hone off any burr and polish.

